



WD M10 12 V4A DWD L400 500 STTZN (478 550)

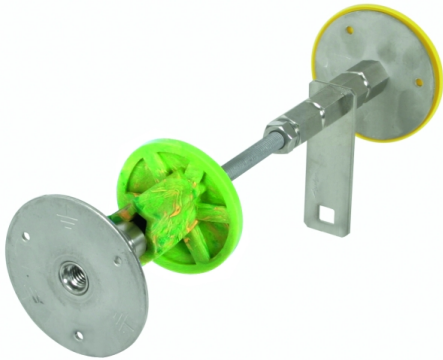
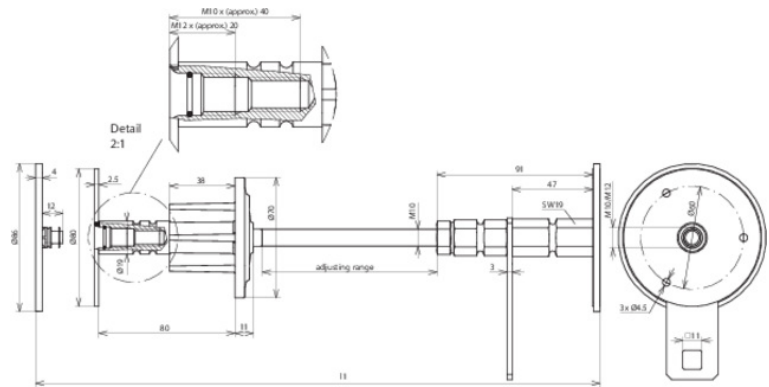

Figure without obligation



Type	WD M10 12 V4A DWD L400 500 STTZN
Part No.	478 550
Material of plate	StSt (V4A)
Material No.	1.4571 / 1.4404 / 1.4401
ASTM / AISI:	316Ti / 316L / 316
Material of axis	St/tZn
Wall thickness (I1)	400-500 mm
Terminal thread	M10 / 12
Terminal plate Ø	80 mm
Pressure-water test	1 bar
Material of water barrier	PVC
Short-circuit current (50 Hz) (1 s; ≤ 300 °C)	4.1 kA
Standard	EN 62561-(1+5)
Weight	838 g
Customs tariff number (Comb. Nomenclature EU)	85389099
GTIN	4013364120365
PU	1 pc(s)

We reserve the right to introduce changes in performance, configuration and technology, dimensions, weights and materials in the course of technical progress. The figures are shown without obligation.