

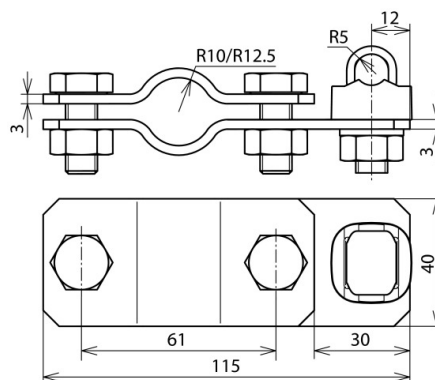

AS TE 25 KSV 7.10 STTZN (625 011)



Figure without obligation



Type	AS TE 25 KSV 7.10 STTZN
Part No.	625 011
Material	St/tZn
Clamping range Rd	7-10 mm
Type for earth rods	Ø25 mm
Screw	M10 x 25 mm
Material of screw / nut	St/tZn
Standard	EN 62561-1
Weight	340 g
Customs tariff number (Comb. Nomenclature EU)	85389099
GTIN	4013364026643
PU	20 pc(s)

We reserve the right to introduce changes in performance, configuration and technology, dimensions, weights and materials in the course of technical progress. The figures are shown without obligation.