

EZ 55 FL45 ASM10 STGALZN (546 000)

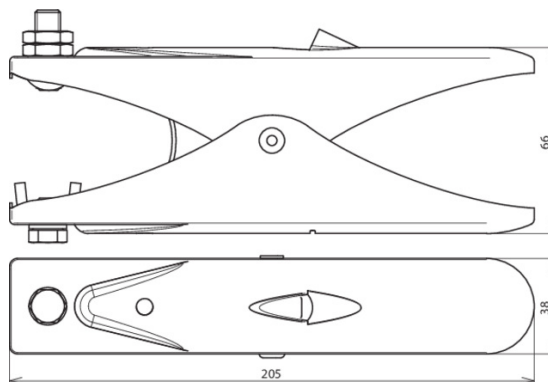

Figure without obligation



Type	EZ 55 FL45 ASM10 STGALZN
Part No.	546 000
Material of tongs	St/gal Zn
Clamping range Rd / FI	up to Ø55 / up to 45 mm
Length	205 mm
Connection nut	M10
Material of screw	StSt
Weight	465 g
Customs tariff number (Comb. Nomenclature EU)	85359000
GTIN	4013364019959
PU	1 pc(s)

We reserve the right to introduce changes in performance, configuration and technology, dimensions, weights and materials in the course of technical progress. The figures are shown without obligation.