

KSS SW10 13 17 19 STGALZN (572 000)

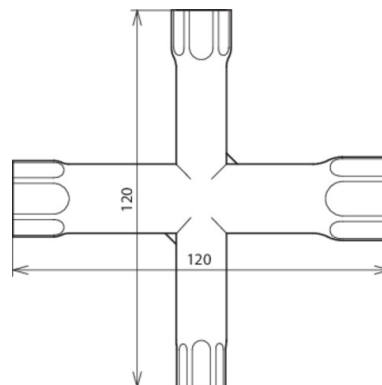

Figure without obligation

Type	KSS SW10 13 17 19 STGALZN
Part No.	572 000
Material	St/gal Zn
Wrench size	10, 13, 17, 19 mm
Weight	198 g
Customs tariff number (Comb. Nomenclature EU)	82055980
GTIN	4013364021723
PU	1 pc(s)

We reserve the right to introduce changes in performance, configuration and technology, dimensions, weights and materials in the course of technical progress. The figures are shown without obligation.