

EL10 L1.05M 1KSO 8.10 1KSG 8 (410 411)

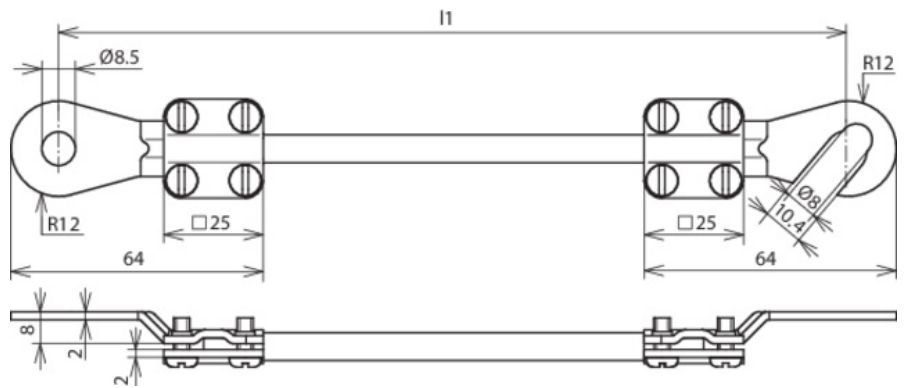

Figure without obligation



Type	EL10 L1.05M 1KSO 8.10 1KSG 8
Part No.	410 411
Cable cross section	10 mm ²
Cable length (l1)	1.05 m
Cable lug open	M8 / M10
Cable lug closed	M8
Bore Ø	8.5 mm
Conductor	Cu highly flexible
Single wire diameter	0.1 mm
Operating voltage resistance (AC / DC)	600 V
Temperature range	-40 °C ... +150 °C
Colour	black •
Cable lug material	Cu/gal Sn
Screw	⬆ M4 x 10 mm
Material of screw	St/gal Zn
Weight	197 g
Customs tariff number (Comb. Nomenclature EU)	85369010
Stock No.	6150-12-192-5457
GTIN	4013364029156
PU	1 pc(s)

We reserve the right to introduce changes in performance, configuration and technology, dimensions, weights and materials in the course of technical progress. The figures are shown without obligation.

Packing in accordance with specifications of the VG standards has to be explicitly indicated when ordering.