

EL16 L2.05M 1KSO 8.10 1KSG 8 (416 420)

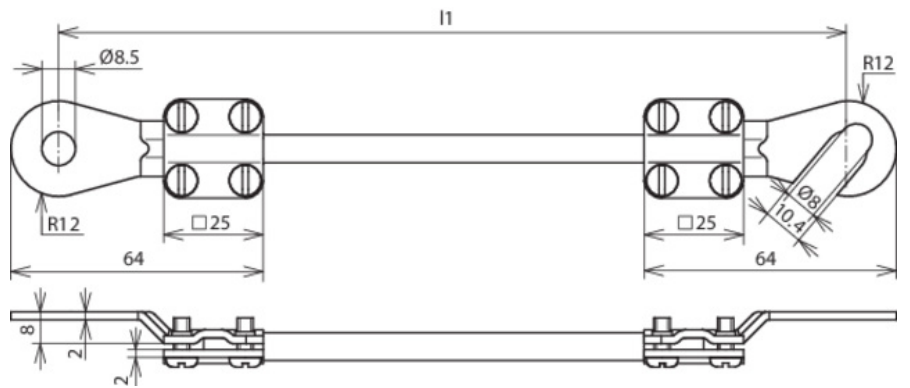

Figure without obligation



Type	EL16 L2.05M 1KSO 8.10 1KSG 8
Part No.	416 420
Cable cross section	16 mm ²
Cable length (l1)	2.05 m
Cable lug open	M8 / M10
Cable lug closed	M8
Bore Ø	8.5 mm
Conductor	Cu highly flexible
Single wire diameter	0.1 mm
Operating voltage resistance (AC / DC)	600 V
Temperature range	-40 °C ... +150 °C
Colour	black •
Cable lug material	Cu/gal Sn
Screw	⬆ M4 x 10 mm
Material of screw	St/gal Zn
Weight	464 g
Customs tariff number (Comb. Nomenclature EU)	85369010
Stock No.	6150-12-308-6933
GTIN	4013364032446
PU	1 pc(s)

We reserve the right to introduce changes in performance, configuration and technology, dimensions, weights and materials in the course of technical progress. The figures are shown without obligation.

Packing in accordance with specifications of the VG standards has to be explicitly indicated when ordering.