

PAK 70 M6 EX KB ER (306 206)

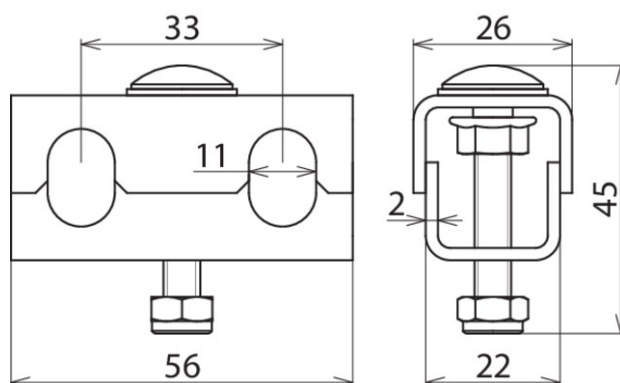

Figure without obligation



EB clamp (PAK) cable tray

- Connection only with ring equipotential bonding conductor 70 mm², Part No. 832 292 (tinned copper cable)
- For mounting on the perforated cable tray or on the EB plate (PAP 1 / PAP 2)
- EB clamp to be mounted approx. every 0.5 m

Type	PAK 70 M6 EX KB ER
Part No.	306 206 <small>NEW</small>
Material	StSt
Connection to	PAP 1 EX KB ER or PAP 2 EX KB ER or cable tray or wide span cable tray
Clamping range (EB ring conductor)	70 mm ² , Cu/gal Sn
Screw	M6 x 35 mm
Material (screw / nut)	StSt
Material No.	1.4301
ASTM / AISI:	AISI 304
EX-zone	2/22
Weight	71 g
Customs tariff number (Comb. Nomenclature EU)	85369010
GTIN	4013364336780
PU	50 pc(s)

We reserve the right to introduce changes in performance, configuration and technology, dimensions, weights and materials in the course of technical progress. The figures are shown without obligation.