

PHEG2 P SN7259 (767 645)



Figure without obligation

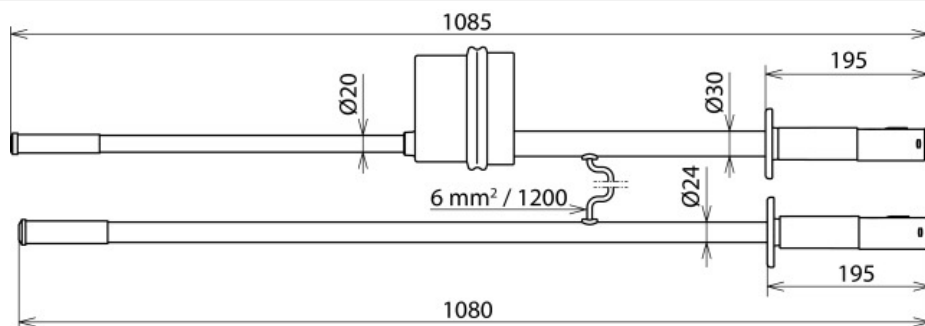

Figure without obligation

Type	PHEG2 P SN7259
Part No.	767 645
Threshold voltage (U_t)	120 V
Nominal voltage (U_N)	1 ... 12 kV
Type of voltage	d.c.
Length (indicator with test prod) (l_s)	600 mm
Length (insulating stick) (l_i)	550 mm
Length (connecting cable)	1200 mm
Total length (l_G)	1085 mm
Standard	Based on EN/IEC 61243-1 (DIN VDE 0682-411)
Temperature range	-25 °C ... +55 °C, climatic category N
For use at	▲
For	Indoor and outdoor installations
Application	Switchgear installations
Design	Two-pole
Indication	Visual
Self-testing element	Yes
Material (test electrode)	Copper alloy/gal Sn
Material (test prod)	Glass-fibre reinforced polyester tube
Material (indicator)	Plastic, fully insulated
Material (insulating stick)	Glass-fibre reinforced polyester tube
Material (connecting cable)	Highly flexible copper cable
Weight	2,6 kg
Customs tariff number (Comb. Nomenclature EU)	90303330
GTIN	4013364156067
PU	1 pc(s)

We reserve the right to introduce changes in performance, configuration and technology, dimensions, weights and materials in the course of technical progress. The figures are shown without obligation.