

KFP 20 W45 M12 (706 200)

- Female thread (not cut)



Figure without obligation

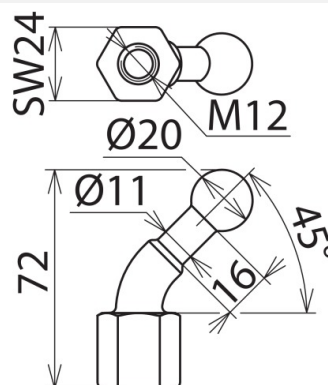

Figure without obligation

Type	KFP 20 W45 M12
Part No.	706 200
Fixed ball point Ø	20 mm
Dimensions	M12
Wrench size	24 mm
Max. cable cross-section Cu	70 mm ²
Max. short-circuit current I _k 0.5 s	19.5 kA
Max. short-circuit current I _k 1 s	13.8 kA
Standard	EN/IEC 61230 (DIN VDE 0683-100) and based on DIN 48088-1
Material (fixed ball point)	E-Cu/gal Sn
Weight	172 g
Customs tariff number (Comb. Nomenclature EU)	85389099
GTIN	4013364004276
PU	1 pc(s)

We reserve the right to introduce changes in performance, configuration and technology, dimensions, weights and materials in the course of technical progress. The figures are shown without obligation.