

EAPA 3 KFP 25 B13 (728 526)



Figure without obligation

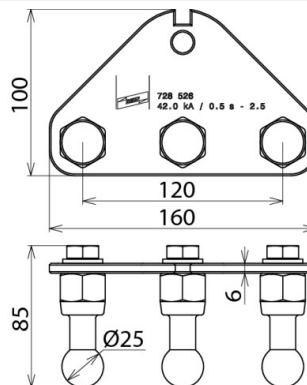

Figure without obligation

Type	EAPA 3 KFP 25 B13
Part No.	728 526
Fixed point Ø	25 mm
Max. cable cross-section Cu	150 mm ²
Max. short-circuit current I _k 0.5 s	42.0 kA
Max. short-circuit current I _k 1 s	29.6 kA
Standard	EN/IEC 61230 (DIN VDE 0683-100) and fixed points in accordance with DIN 48088-1
Material (plate)	Aluminium
Material (fixed point)	E-Cu/gal Sn
Material (threaded pin)	StSt A2-70
Weight	934 g
Customs tariff number (Comb. Nomenclature EU)	85389099
GTIN	4013364147881
PU	1 pc(s)

We reserve the right to introduce changes in performance, configuration and technology, dimensions, weights and materials in the course of technical progress. The figures are shown without obligation.