

RBK 25 SQ SN7151 (715 314)

- Earthing and short-circuiting devices can be configured online via the earthing and short-circuiting configurator



Figure without obligation

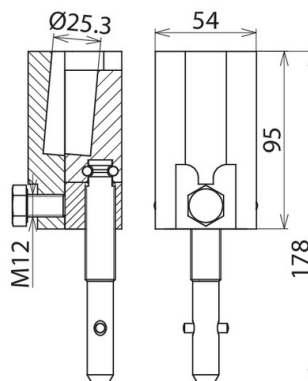

Figure without obligation

Type	RBK 25 SQ SN7151
Part No.	715 314
For round pins Ø	25 mm
Anti-rotation element	PK1
For cable cross-section Cu	16 ... 150 mm ²
Max. short-circuit current I _k 0.5 s	42.0 kA
Max. short-circuit current I _k 1 s	29.6 kA
Standard	EN/IEC 61230 (DIN VDE 0683-100), threaded T pin shaft DIN 48087
Temperature range	-25 °C ... +55 °C
Material (clamp body)	Copper alloy/gal Sn
Material (shaft)	Copper alloy/gal Sn
Material (pressure plate)	Copper alloy/gal Sn
Weight	1,61 kg
Customs tariff number (Comb. Nomenclature EU)	85359000
GTIN	4013364132474
PU	1 pc(s)

We reserve the right to introduce changes in performance, configuration and technology, dimensions, weights and materials in the course of technical progress. The figures are shown without obligation.

The clamps must have the same maximum short-circuit current as the earthing and short-circuiting cables!