



## Safety Equipment

# Instructions for use

### TRS MS dry cleaning kit

Equipment for suction cleaning under live conditions  
up to 36 kV / 15 - 60 Hz  
in accordance with DIN VDE 0682 Part 621



# Contents

<b>1. General instructions for use</b> .....	<b>4</b>
1.1 General .....	4
Working procedures, work location, protective equipment, protection measures, instructions, environmental conditions	
1.2 Special training .....	6
Maintenance of ability	
1.3 Organisation of work procedures.....	6
Preparation for work	
Measures taken by the nominated person in control of the electrical installation	
Measures taken by the nominated person in control of the work activity	
1.4 Environmental conditions.....	8
Thunderstorms	
Audible and visible pre-discharges	
Earth-faulted installations	
Weather conditions	
<b>2. Application notes for the user</b> .....	<b>10</b>
2.1 Ambient temperature.....	10
2.2 Nominal voltages (factory assembled, type-tested installations) .....	10
2.3 Minimum distance.....	10
2.4 Visual inspection of the installation .....	11
2.5 Visual inspection of the cleaning kit.....	11
2.6 Cleaning work.....	12
2.7 Rating plates.....	13
2.8 Intake tube with handle .....	14
2.9 Assembly (combinations) of the TRS MS dry cleaning kit .....	15
2.10 Combination examples.....	20
2.11 Cleaning equipment parts during maintenance work .....	22
<b>3. Maintenance tests</b> .....	<b>24</b>
<b>4. Cleaning for long-term storage</b> .....	<b>24</b>
<b>5. Transport and storage</b> .....	<b>25</b>
5.1 Transport.....	25
5.2 Storage.....	25
5.3 Protection against UV radiation .....	25
<b>6. Instructions and requirements for industrial vacuum cleaners</b> .....	<b>25</b>
<b>7. Standards</b> .....	<b>26</b>
<b>8. Parts List</b> .....	<b>27</b>
<b>9. Accessoires</b> .....	<b>28</b>
<b>Elements of the dry cleaning kit</b> .....	<b>29</b>

## Special safety instructions

Only electrically skilled persons with adequate training are allowed to carry out dry suction cleaning under live conditions. BGV A3 §8, BGR A3 and EN 50110-1:2004, subclauses 6.3.1 to 6.3.12, must be observed. The training must comprise theoretical and practical exercises.

Dry suction cleaning under live conditions may only be performed based on a risk assessment and upon authorisation.

Dry suction cleaning under live conditions may only be performed if fire and explosion protection measures were taken [see B2 and B3 of EN 50110-1:2004].



Before use, the TRS MS dry cleaning kit must be checked for proper condition. If parts of the TRS MS dry cleaning kit are damaged, soiled or moist, the kit must not be used.

The equipment may only be used under the conditions shown and referred to in these instructions for use.

Cleaning work may only be performed under the following climatic conditions:

- Permissible relative air humidity up to 80 % at temperatures < 25 °C
- Permissible relative air humidity up to 65 % at temperatures > 25 °C

The dry cleaning kit must not be used in wet weather conditions.

If only one of the safety instructions is not strictly followed or disregarded, *life and health* of the user and system availability will be threatened.

Tampering with or modification of the TRS MS dry cleaning kit or the installation of components from other manufacturers or of other types will threaten occupational safety, are impermissible and will void warranty.

## 1. General instructions for use in accordance with EN 50110-1:2004

### 1.1 General

During live working, workers contact bare live parts with parts of their bodies, tools, equipment or devices or enter the live working zone. The live working zone is limited by the distance  $D_L$  (see figure below).

The values for the distance  $D_L$  are listed in the normative national annexes of DIN VDE 0105-100:2006-06.

If no values are stipulated non the national level,  $D_L$  can also be selected based on the distances for the design and installation of electrical systems. Recommended values for these distances can be found in EN 50110-1:2004.

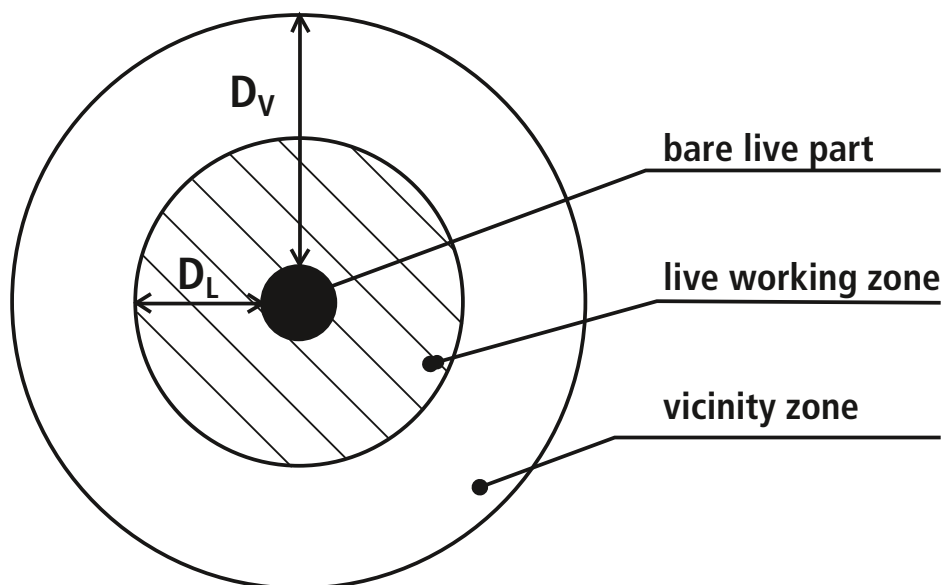

$D_L$ : Distance defining the outer limit of the live working zone

$D_V$ : Distance defining the outer limit of the vicinity zone

1.1.1 Presently, there are three recognised working procedures which are classified according to the position of the worker from live parts and equipment to prevent electric shock and short circuits:

- Bare hand working,
- Insulating glove working,
- Hot stick working.

The hot stick working procedure is used for dry suction cleaning under live conditions. During this procedure, the worker keeps a specified distance from live parts and carries out work by means of insulating sticks (in this case intake tubes).

1.1.2 A stable work location must be provided which ensures that the worker is able to work with both hands free.

1.1.3 Workers must wear suitable personal protective equipment. They must not wear any metal parts such as jewellery if this is likely to cause a hazard.

1.1.4 During live working, protection measures to prevent electric shock and arc faults must be taken. All different potentials (voltages) in the vicinity of the work location must be considered.

1.1.5 Instructions must be given how to test tools, equipment and devices and how to keep them in good order and condition. For details, see subclause 6.3.6 of EN 50110-1:2004.

1.1.6 Environmental conditions such as humidity and air pressure may negatively affect the work to be carried out. Resulting limitations must be defined. For details see subclause 6.3.7 in EN 50110-1:2004.

## 1.2 Special training

A specific training programme must be set out to ensure that skilled or instructed persons develop and maintain the ability of live working.

This programme must comply with the special requirements for live working and must be based on theoretical and practical exercises.

These exercises must be representative of the work to be carried out after the training or, if this is not possible, they must be based on the same safety principles.

On the successful completion of the training, the participants receive a certificate stating the work for which they have been trained.

The level of ability should be confirmed in a live working certificate.

### 1.2.1 Maintenance of ability

The ability to carry out live working must be maintained either in practice or by attending a refresher training.

## 1.3 Organisation of work procedures

### 1.3.1 Preparation for work

If there is any doubt about the procedures to be used, preliminary trials must be carried out before starting work.

All electrical and other aspects of safety must be considered during preparation for work. For complex work, this preparation must be performed in writing and in time.

### 1.3.2 Measures taken by the nominated person in control of the electrical installation

The installation or the part where work (cleaning) is to be carried out must be put into the state as defined during preparation.

This may include the prevention of automatic resets re-connection and modification of the settings of electrical protective devices.



The place where automatic re-connection is prevented should be marked with a sign showing that of live working in progress.

Depending on the complexity of work, adequate communication connections between the work location and the relevant supervision point must be used.

### **1.3.3 Measures taken by the nominated person in control of the work activity**

The nominated person in control of the work activity must inform the nominated person in control of the electrical installation about the nature and location of the work to be carried out.

Before work begins, explanations must be given to the workers on the complexity of work, safety aspects and the role of each worker concerning the use of tools and equipment.

The level of supervision must correspond to the complexity of the work activity and the voltage level.

The nominated person in control of the work activity must consider the environmental conditions at the work location.

The permission to start work may only be given to the workers by the nominated person in control of the electrical installation.

After the work has been completed, the nominated person in control of the work activity must inform the nominated person in control of the electrical installation in the required manner. If the work is interrupted, adequate safety measures must be taken and the nominated person in control of the electrical installation must be notified.

## 1.4 Environmental conditions

In the event of adverse environmental conditions, restrictions must be applied to live working which consider the reduction of insulating properties and the reduced visibility and impaired movement of the worker.

When environmental conditions require the work to be interrupted, personnel must leave the installation and all insulating and insulated equipment in a safe state. They must also leave the work location in a safe manner.

Before restarting the interrupted work, the worker must check if the insulating parts are clean and dry.

If parts of the TRS MS dry cleaning kit require to be cleaned, 2.11 of these instructions for use has to be observed.

- 1.4.1 **If a thunderstorm occurs, cleaning work** in installations, which are connected to overhead lines either directly or via short cables, **must not be started or must be interrupted** (for details see also 1.3.3).
- 1.4.2 In installations with **audible and/or visible** pre-discharge, **no cleaning work** may be carried out (see 1.3.3).
- 1.4.3 **Cleaning work** must **not** be carried out in **earth-faulted installations**.
- 1.4.4 The following **weather conditions** must be considered when assessing the environmental conditions:

<b><i>Weather conditions</i></b>	<b><i>Description</i></b>	<b><i>Attention: To be considered in</i></b>
<b>Wet weather</b>	Wet weather means rain, snow, hail, drizzle, spray or hoarfrost. The TRS MS dry cleaning kit must <b>not</b> be used in wet weather conditions.	<b>Outdoor installations</b>
<b>Dense fog</b>	The TRS MS dry cleaning kit must <b>not</b> be used in dense fog.	<b>Outdoor installations</b>



<b><i>Weather conditions</i></b>	<b><i>Description</i></b>	<b><i>Attention: Taking this into consideration at</i></b>
<b>Thunderstorms</b>	Thunderstorms consist of lightning and thunder. As soon as one of the workers notices lightning and/or thunder, work should be stopped if they are working on bare conductors, overhead lines or switchgear installations connected to them. The TRS MS dry cleaning kit must <b>not</b> be used in thunderstorms.	<b>Indoor installations Outdoor installations</b>
<b>Strong wind</b>	Winds are strong if they prevent workers from using their tools and devices with sufficient precision; in this case, work should be stopped. The TRS MS dry cleaning kit must <b>not</b> be used in strong winds.	<b>Outdoor installations</b>
<b>Salt storms</b>	These strong winds carry salt-laden moisture from the sea to the land. The insulation level will be reduced or flashover will occur when there is subsequent fog or drizzle or the air humidity increases significantly. The TRS MS dry cleaning kit must <b>not</b> be used in salt winds.	<b>Outdoor installations</b>
<b>Extremely low temperatures</b>	Temperatures are extremely low if it is difficult to use tools and the durability of materials is reduced. In this case work should be stopped .	<b>Indoor installations Outdoor installations</b>

## 2. Application notes for the user

When using the TRS MS dry cleaning kit, the following points must be observed:

- 2.1 Ambient temperature -10 ... 50°C
- 2.2 According to the rating plate, the TRS MS dry cleaning kit can be used up to 36 kV.

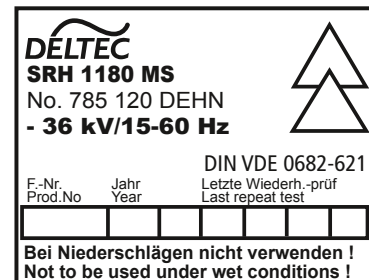

The TRS MS dry cleaning kit is not suitable for all factory assembled (type-tested) installations. The user of the TRS MS dry cleaning kit or the operator of the switchgear installation must consult the manufacturer of the factory assembled switchgear installation to find out whether and where the TRS MS dry cleaning kit may be used.

### 2.3 Minimum distance

Barriers must be located at a height of approx. 600 mm and 1200 mm to keep a minimum distance from live parts. For the required minimum distance, see Table A.2 "Guidance for distances..." of EN 50110-1:2004.

If there are no barriers, they must be fixed at the above mentioned distances before starting to work.

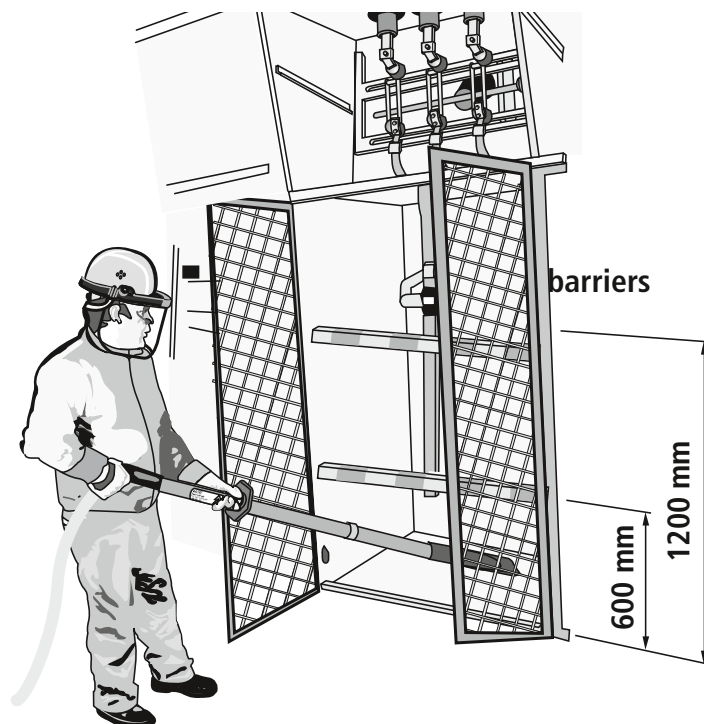

## 2.4. Visual inspection of the installation

- 2.4.1 Before starting cleaning work, insulators, bushings and inaccessible parts of the installation must be checked for possible hazard sources using insulating mirrors or insulating cameras.

## 2.5 Visual inspection of the cleaning kit

All parts of the TRS MS dry cleaning kit must be visually inspected prior to use.

- 2.5.1 No part may show signs of damage such as leakage current effects, scratches or other deformations.
- 2.5.2 All parts of the TRS MS dry cleaning kit (intake tube, extensions, cleaning heads, etc.) must be in a clean and dry state before they are used.
- 2.5.3 Condensed parts must be wiped clean.  
Condensation occurs if equipment stored in a cool place is brought into a warmer environment. The equipment must be slowly adapted to the higher temperature.
- 2.5.4 It is advisable to use gloves for all equipment parts and to place them on plastic covers, racks or transport cases.

## 2.6 Cleaning work

2.6.1 Before starting and during cleaning work, the limit values of the permissible relative air humidity and ambient temperature must be tested using the combined measuring device supplied with the TRS MS dry cleaning kit.

- Permissible relative air humidity up to 80 % at temperatures < 25°C
- Permissible relative air humidity up to 65 % at temperatures > 25°C

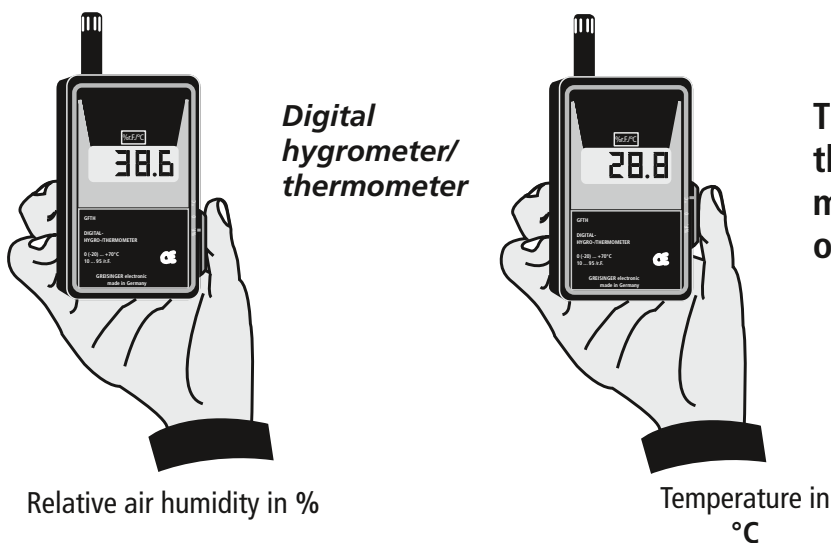

*Digital  
hygrometer/  
thermometer*

**The instructions for use of  
the GFTH 95 combined  
measuring device must be  
observed!**

Relative air humidity in %

Temperature in  
°C

### 2.6.2 Primary cleaning / final cleaning

For safety reasons, it is recommended to clean tough pollution layers and inaccessible parts of the installation in two steps.

2.6.2.1 Flat cleaning heads should be used to remove cobwebs and tough pollution layers (primary cleaning). In this process, it should be prevented that dust layers are stirred up.

2.6.2.2 Tubular and half-round brushes should be used in a second step (final cleaning). In case of extremely narrow distances in the installation, flat cleaning heads with brush should be used. When cleaning insulators or bushings, the brushes must be checked for pollution layers before starting and during cleaning work.

2.6.3 In case of oily, greasy and tough pollution layers, the FRS NS dry cleaning kit must be used (Part No. 785 939).

## 2.7 Rating plates

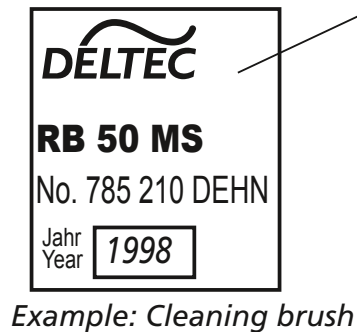
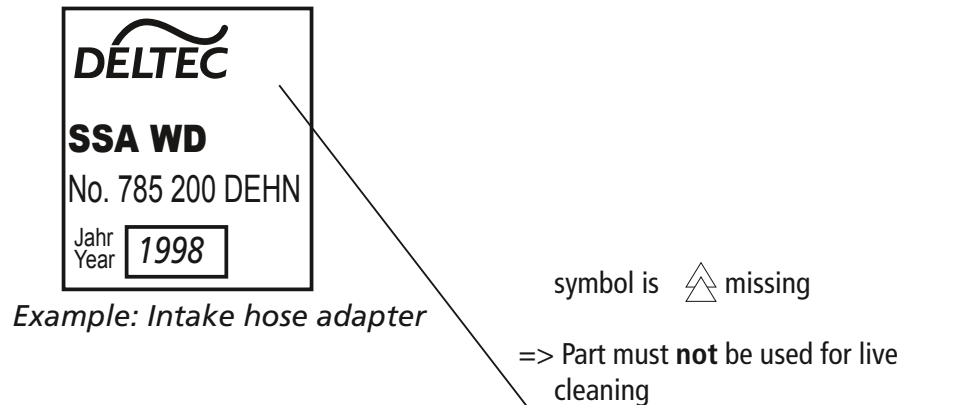
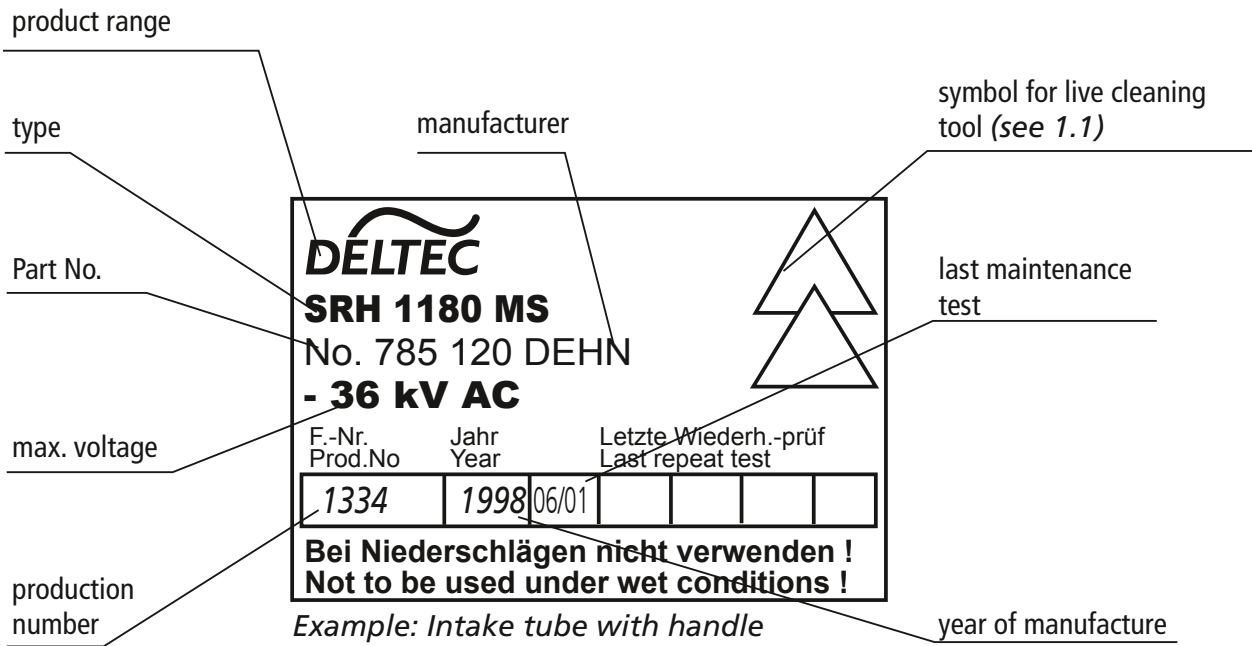

## 2.8 Intake tube with handle

The **hand guard** and the **red ring** limit the **insulating element**.

Only the section from the **cleaning head** to the **red ring** of the intake tube, optionally with **extension(s)** or **angled intake tube(s)**, may contact live parts. The sections from the cleaning head to the hand guard may contact earthed parts of installations.

Pos. 30 Intake tube with handle and extension

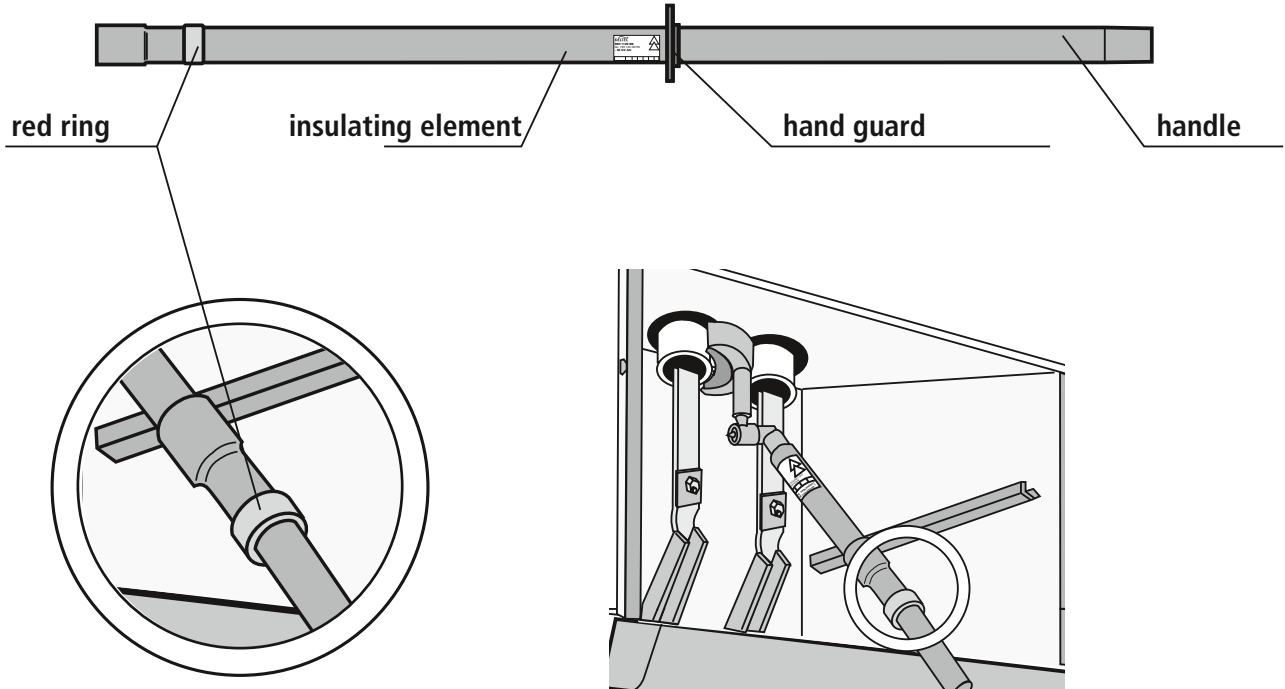

The intake tube may only be taken by the handle namely up to the hand guard.

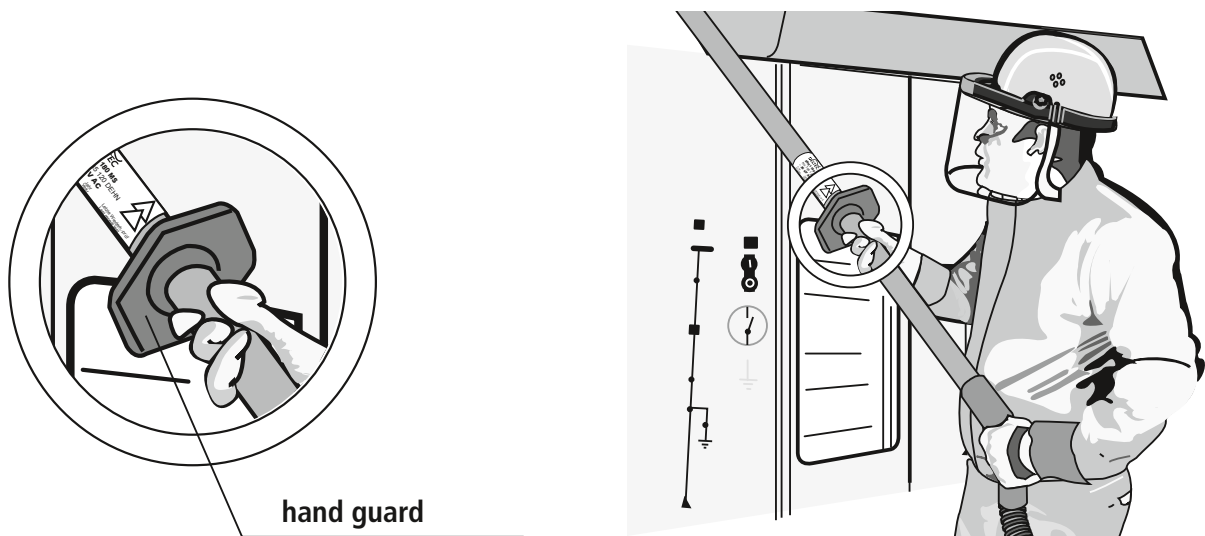

## 2.9 Assembly (combinations) of the TRS MS dry cleaning kit

The single parts such as intake tube, intake tube extensions and angled intake tube are fitted with a plug-in coupling system, allowing quick combination of the single parts. The plug-in coupling system is tested for a minimum tensile force  $> 200\text{ N}$  and a minimum torsional strength  $> 3\text{ Nm}$ .

### 2.9.1 Extension section of the intake tube

All single parts of the TRS MS dry cleaning kit marked with a double triangle can be freely combined in the extension section of the intake tube (Pos. 30) above the red ring (see page 29, Figs. 1a and 1b).

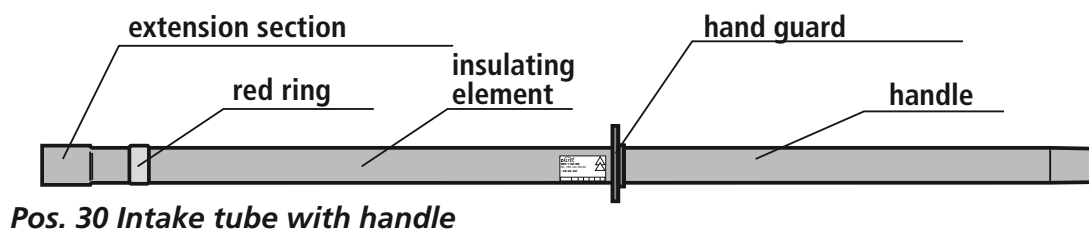

For parts of the installation that cannot be easily reached such as covered parts in a row, angled intake tubes (Pos. 70 or Pos. 80) and extensions (Pos. 40, 50, 60) have to be used (see page 29, Figs. 1a and 1b).

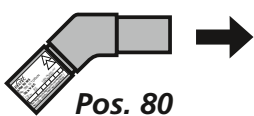
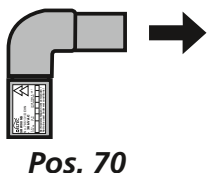
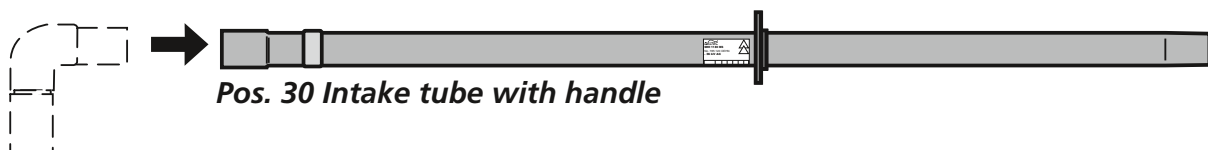

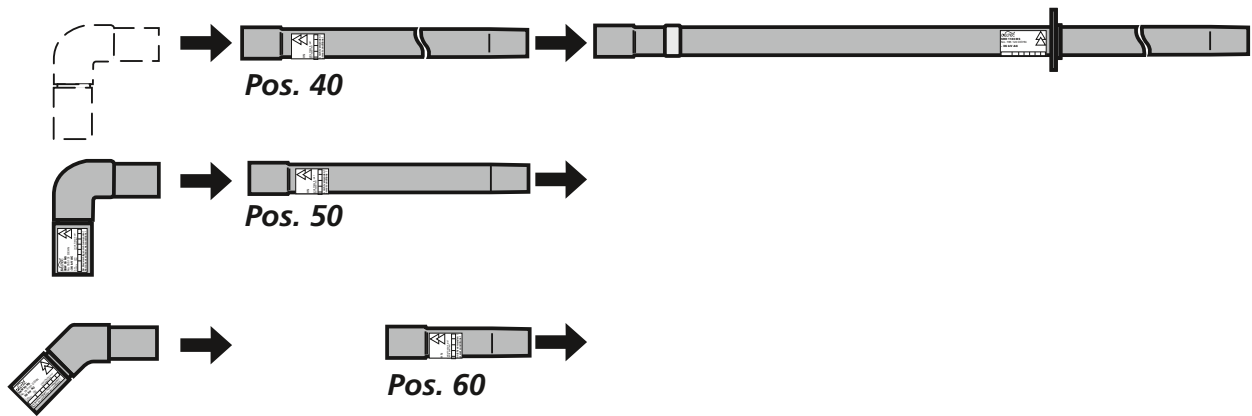

## 2.9.2 Working with flat cleaning heads

### Warning:

At first, primary cleaning, for example removing cobwebs and dust deposits, has to be performed with cleaning heads (Pos. 150 and Pos. 160). Ensure that no dust is stirred up. When performing *WORK* with *FLAT CLEANING HEADS*, a max. extension length of  $l_{Vmax} = 2115 \text{ mm}$  is permitted (see page 29, Fig. 1 a and 1b).

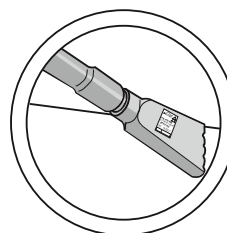
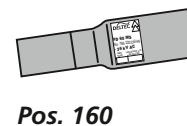
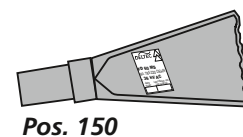



### 2.9.3 Complete cleaning of insulators and bushings

For completely cleaning vertically and horizontally arranged insulators and bushings, a half-round brush (Pos. 100 or Pos. 110) has to be mounted at the angled intake tube (Pos. 90). This combination allows to rotate the half-round brush around the entire insulator. When *WORKING* with *BRUSHES*, a max. extension length of  $l_{Vmax} = 1315$  mm is permitted (see page 29, Figs. 1a and 1b).

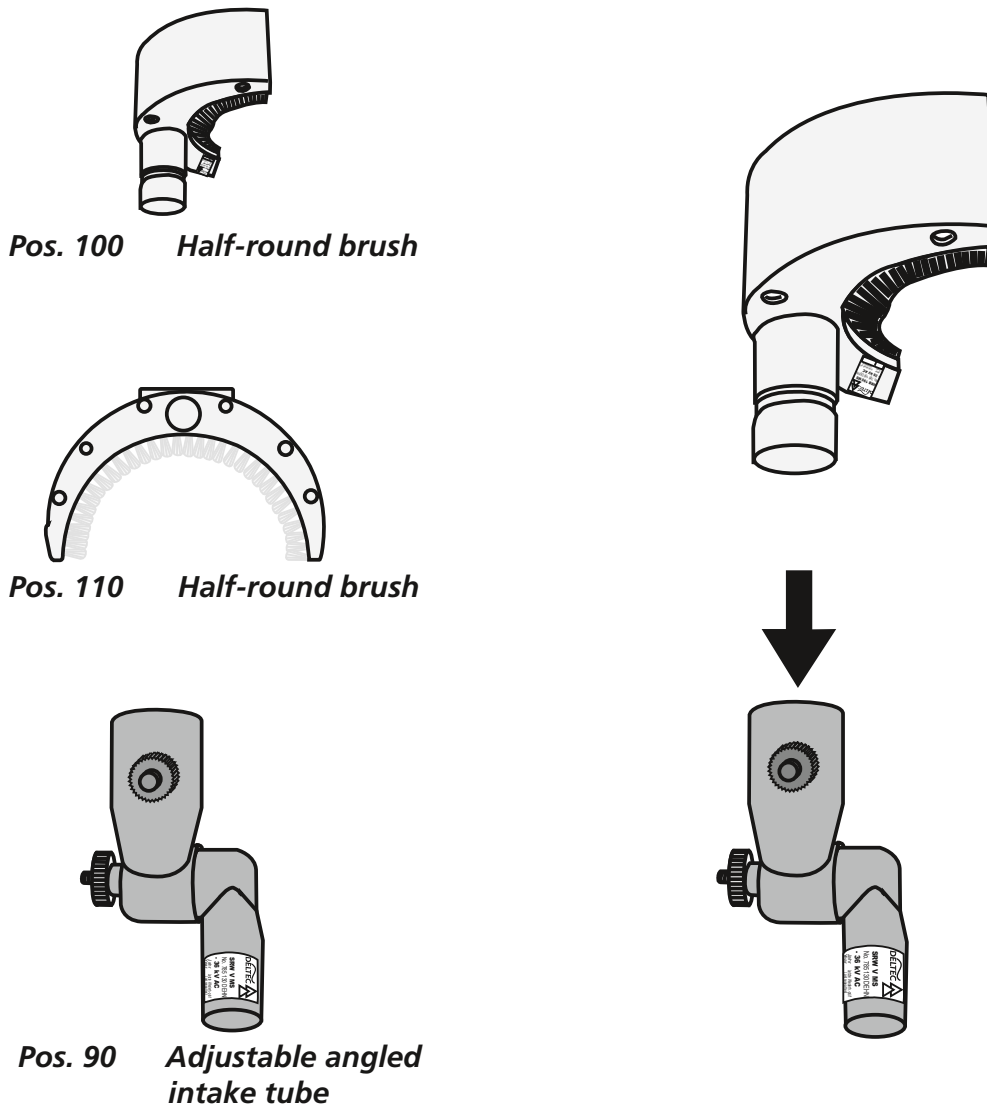

Do not use brushes (Pos. 100 - Pos. 140) to clean oily, greasy surfaces. Oily, greasy and tough dirt layers are removed by means of the **FRS MS damp cleaning kit** (Part No. 785 939). **FRS MS damp cleaning kit** (Part No. 785 939).



*Practical application example of the **complete cleaning process for insulators and bushings** (see 2.9.3) with a half-round brush (Pos. 100 and 110) and an adjustable angled intake tube.*

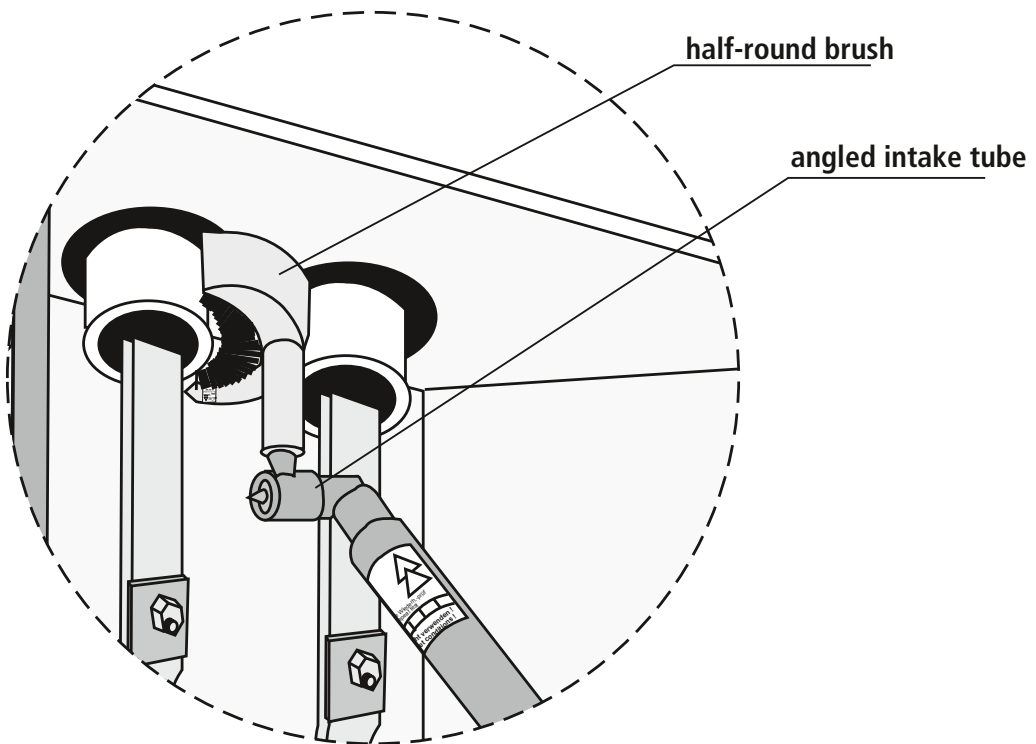

## 2.9.4 Intake hose adapter (Pos. 190)

The intake hose adapter (Pos. 190) is intended to connect the intake hose (optional accessory) to the intake tube with handle (Pos. 30). The intake hose adapter (Pos. 190) included in the TRS MS dry cleaning kit fits the intake hose system (Ø 35 mm) with a straight connector from STARMIX with a length of 3.5 m, Part No. 42 8512, and 5 m, Part No. 42 6723. DEHN + SÖHNE also offers reducing inserts (Pos. 200 - 206) for intake hoses from other manufactures (with different diameters).

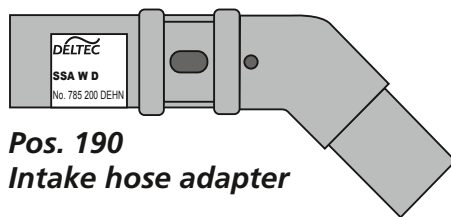

**Pos. 190**  
**Intake hose adapter**

### Accessories:

Reducing inserts (Pos. 200 - 206) are not included in the dry cleaning kits, Part No. 785 100 and 785 112.

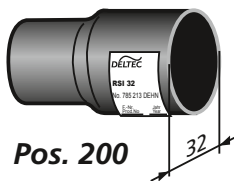

**Pos. 200**

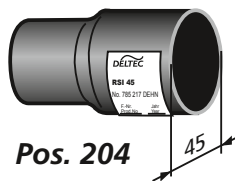

**Pos. 204**

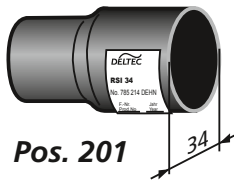

**Pos. 201**

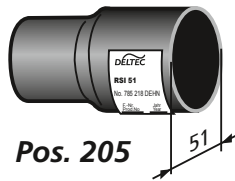

**Pos. 205**

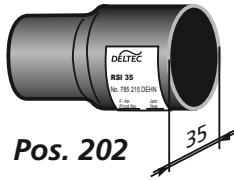

**Pos. 202**

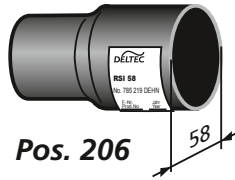

**Pos. 206**

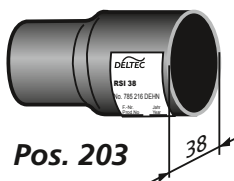

**Pos. 203**

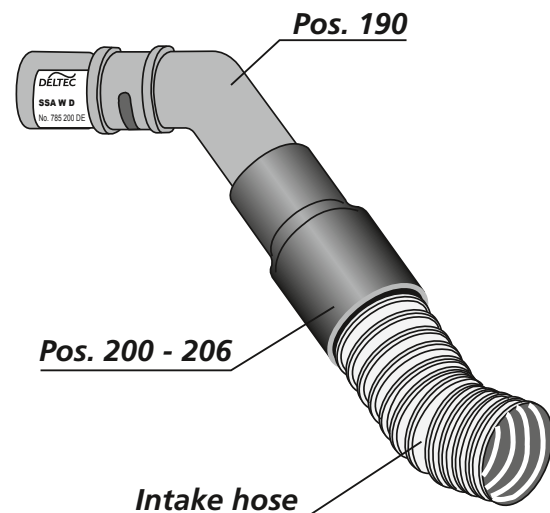

## 2.10 Combination examples

### - Working with rectangular brushes (Pos. 120)

Intake hose adapter (Pos. 190), intake tube (Pos. 30), angled intake tube (Pos. 80), extension (Pos. 60), rectangular brush (Pos. 120)

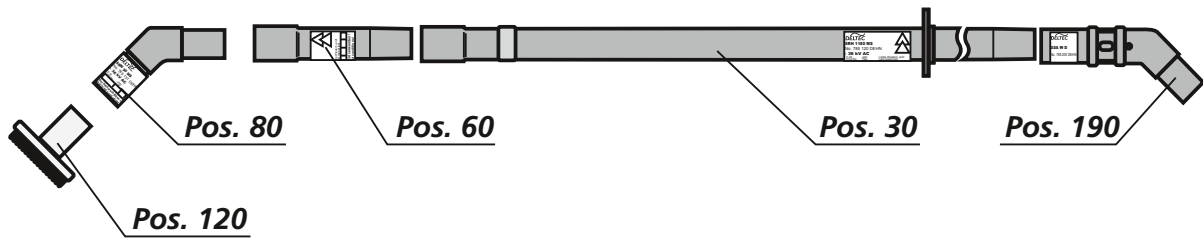

(see page 29, Fig. 1a and 1b)

### - Working with half-round brushes (Pos. 100)

Intake tube extension (Pos. 60), intake tube (Pos. 30), extension (Pos. 50), angled intake tube (Pos. 90), half-round brush (Pos. 100). This combination is the maximum extension!

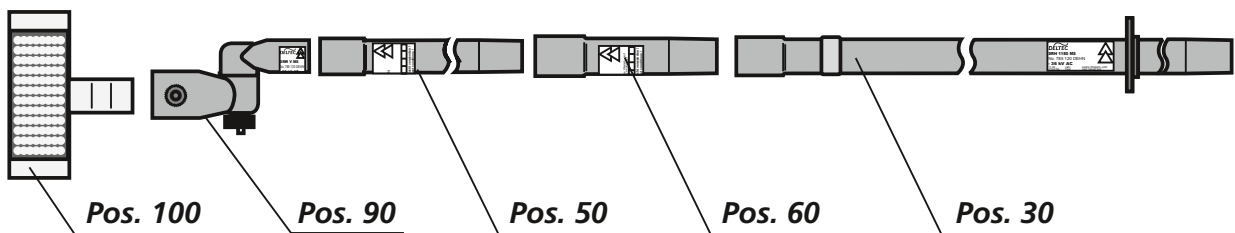

(see page 29, Fig. 1a and 1b)

### - Working with flat cleaning heads (Pos. 160)

Intake hose adapter (Pos. 190), intake tube (Pos. 30), 2 extensions (Pos. 40), extension (Pos. 50), cleaning head (Pos. 160)

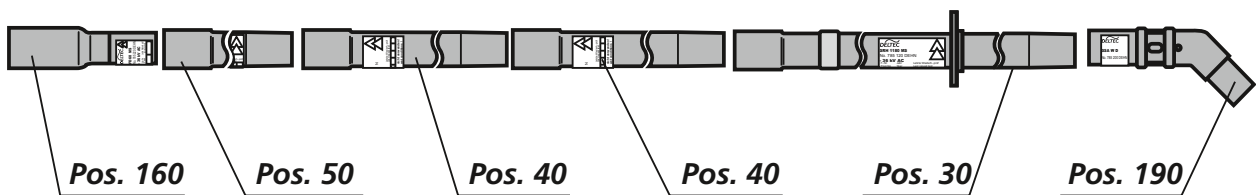

(see page 29, Fig. 1a and 1b)

- Working with tubular brushes (Pos. 130)

Intake hose adapter (Pos. 190), intake tube (Pos. 30), extension (Pos. 40), brush (Pos. 130)

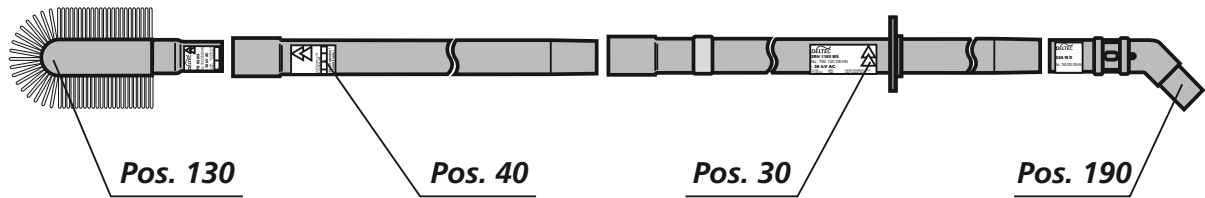

(see page 29, Fig. 1a and 1b)

- Working with tubular brushes (Pos. 131 - Pos. 132)

Intake hose adapter (Pos. 190), intake tube (Pos. 30), extension (Pos. 40), angled intake tube (Pos. 80), intake tube extension (Pos. 60)

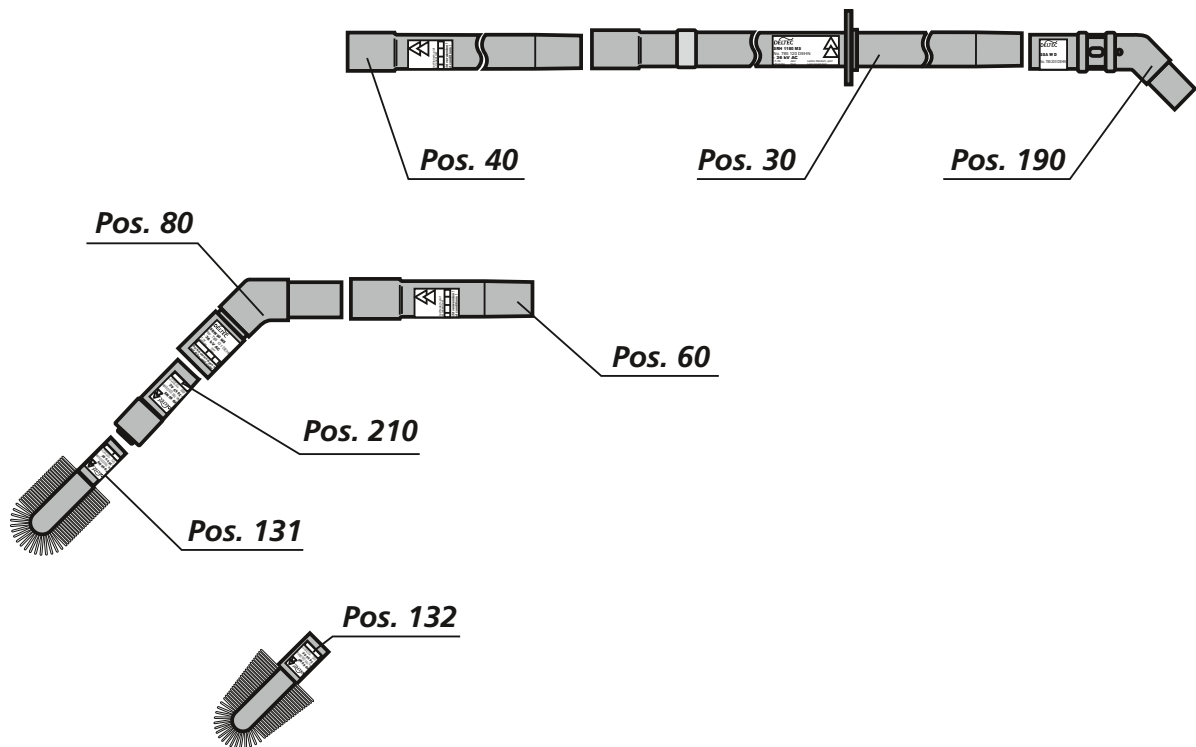

(see page 29, Fig. 1a and 1b)

## 2.11 Cleaning equipment parts during maintenance work

2.11.1 It may be necessary to clean the *brushes* during work, depending on the degree of pollution.

It is advisable to clean the brushes with an industrial vacuum cleaner.

A cleaning brush can be used to clean the intake tubes and their extensions (Pos. 140).

This is a dry cleaning procedure.

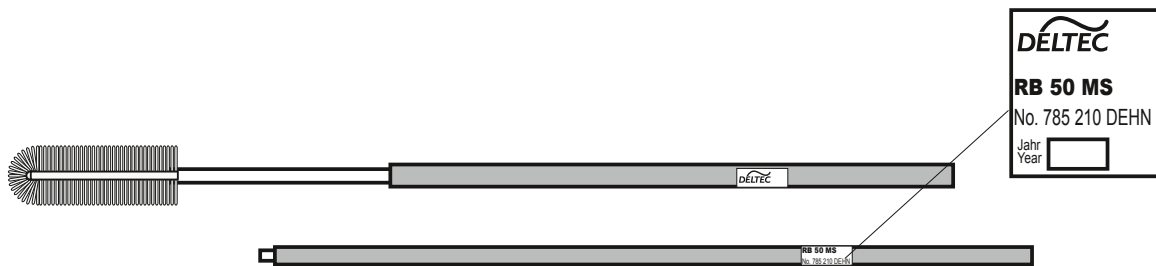

*Pos. 140 Cleaning brush with threaded extension*

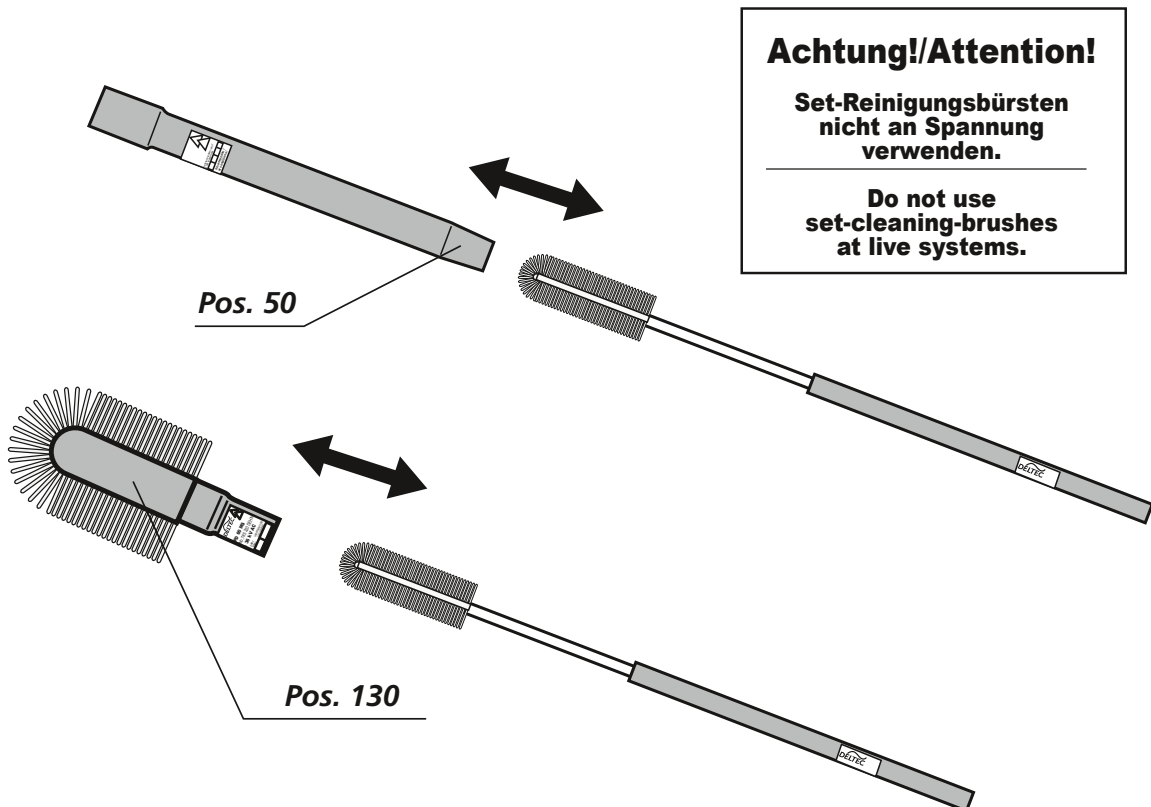



If the original state of parts of the TRS MS dry cleaning kit cannot be restored by cleaning, they must be replaced by new ones!

### 2.11.2 Soiled equipment parts must be cleaned using the following approved cleaning liquids:

- Rivolta B.W.R 210
- Rivolta S.L.X.-Top

Observe the manufacturer's data sheets when using these products!

- ➔ After the cleaning process, operating heads, angled intake tubes, extensions and intake tubes must be wiped with a (clean) white cloth. A (clean) white cloth must be pulled through the tubes to remove residual pollution.

The parts may only be used again as soon as they are completely dry and clean.

Only then, cleaning work may be continued in the installation.

### 3. Maintenance tests

Maintenance tests and intervals are stipulated in the German accident prevention regulations and operational provisions. If no test intervals are required, the test intervals for the TRS MS dry cleaning kit depend on its conditions of use, namely the frequency of use, environmental conditions, wear and transport.

***The test intervals should not exceed 6 years***

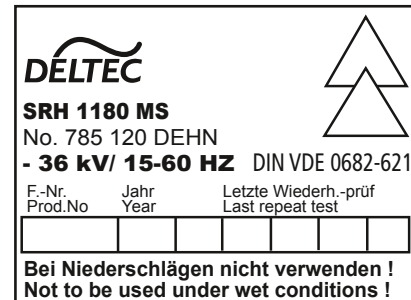

### 4. Cleaning for long-term storage

It is generally recommended to clean heavily soiled equipment parts such as intake tubes, intake tube extensions, brushes and angled intake tubes **with warm water and mild detergent**.

For cleaning brushes made of natural hair, a conventional shampoo is recommended.

After cleaning, the equipment must be rinsed carefully, shaken and dried.

After drying for twelve hours at min. 20°C, the equipment can be stored or used again. Hardly visible areas inside the tubes must be additionally checked for deposits by pulling a white (clean) cloth with a cleaning chain through it.



Only use dry parts that are returned to their original state. If this is not possible, replace the parts!

Do not use cleaning agents containing alcohol!



## 5. Transport and storage

Insulating equipment parts must be stored and transported so that they are protected from deterioration.

### 5.1 Transport

The TRS MS dry cleaning kit is transported in a transport case. The individual equipment parts are stored in the supports of the case. This protects the surface of the insulating material from scratches, abrasion or roughening. Insulating equipment parts must not be placed on top of one another. Parts that are not part of the equipment must not be stored or transported in the transport case.

### 5.2 Storage

- ➔ Equipment is to be stored in closed rooms,
- ➔ Relative air humidity < 85 %,
- ➔ Air temperature of - 25°C up to max. + 70°C,
- ➔ No direct sun light

### 5.3 Protection against UV radiation

Some insulating materials are sensitive to UV radiation. Insulating equipment should therefore not be exposed to direct sun light for longer than necessary.

## 6. Instructions and requirements for industrial vacuum cleaners

The vacuum cleaner must fulfil the following requirements:

- ➔ Minimum air velocity of  $\geq 20$  m/s.
- ➔ The industrial vacuum cleaner must have a visual intake capacity control.
- ➔ Intake hoses must not contain any metal parts.
- ➔ Intake hoses must have a consistent inner diameter of  $\geq 30$  mm.
- ➔ Accessories for the industrial vacuum cleaner must not be used for live cleaning.

## 7. Standards

- ➔ EN 50110-1:2004: Operation of electrical installations.
- ➔ DIN EN 50110-1 (VDE 0105 Part 1):1997-10: Operation of electrical installations
- DIN EN 50110-2 (VDE 0105 Part 2): 1997-10: Operation of electrical installations (national annexes).
- ➔ DIN VDE 0101 (VDE 0101): 2000-01: Power installations exceeding 1 kV
- ➔ E DIN VDE 0682-621 (VDE 0682 Part 621): 2000-12: Live working - Cleaning of medium- and low-voltage systems by means of an exhausting device.

**Keep these instructions for use in the support of the transport case intended for this purpose for future reference!**

## 8. Parts list (for parts included in the case, see page 29)

Pos.	No.	Item	Type	Part No.
10	1	TRS MS dry cleaning kit	TRS MS	785 100
11	1	TRS MS V1 dry cleaning kit	TRS MS V1	785 112
20	1	Sheet metal case, empty	SKL TRS MS	785 300
30	1	Intake tube with handle	SRH 1180 MS	785 120
40	2/1	Intake tube extension	SRV 800 MS	785 123
50	2	Intake tube extension	SRV 400 MS	785 122
60	2	Intake tube extension	SRV 200 MS	785 121
70	1	Angled intake tube	SRW 90 MS	785 131
80	1	Angled intake tube	SRW 135 MS	785 132
90	1	Angled intake tube, adjustable	SRW V MS	785 130
100	1	Half-round brush	HRB 120 MS	785 140
110	1	Half-round brush	HRB 190 MS	785 150
120	1	Rectangular brush	REB 1095 MS	785 160
130	1	Tubular brush	STB 120 MS	785 170
131	1	Tubular brush	STB 80 MS	785 171
132	1	Conical tubular brush	STB 80 K MS	785 172
140	1	Cleaning brush	RB 50 MS	785 210
150	1	Flat cleaning head	FD 110 MS	785 221
160	1	Flat cleaning head	FD 60 MS	785 220
170	1	Insulating mirror	ISP 135 MS	785 190
180	1	Digital hygrometer/thermometer	DHTM	785 180
190	1	Intake hose adapter	SSA WD	785 200

## 9. Accessoires

POS. 200 - 240 NOT INCLUDED IN DELIVERY

Pos.	No.	Item	Type	Part. No.
200	1	Reducing insert	RSI 32	785 213
201	1	Reducing insert	RSI 34	785 214
202	1	Reducing insert	RSI 35	785 215
203	1	Reducing insert	RSI 38	785 216
204	1	Reducing insert	RSI 45	785 217
205	1	Reducing insert	RSI 51	785 218
206	1	Reducing insert	RSI 58	785 219
210	1	Intake tube adapter	SRAMS	785 212
220	1	Arc brush	BB 245 MS	785 251
230	1	Cover	AP 152 G	785 110
240	1	Canvas bag	TT 550 OL	785 111

Pos. 220

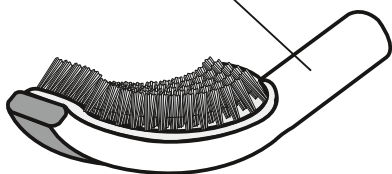

Pos. 240



Pos. 230

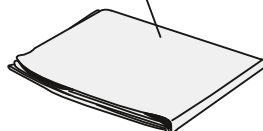

GA = Instructions for use

**Fig. 1a**

**Part No. 785 100**  
**Type: TRS MS**

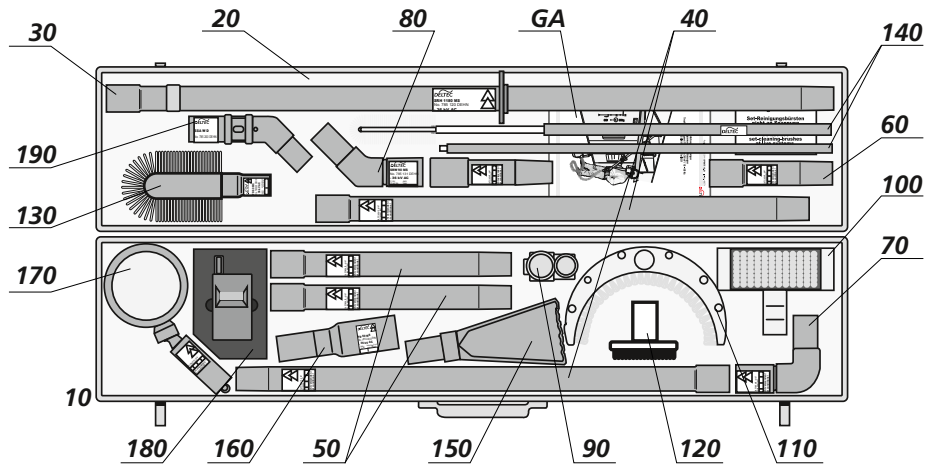

**Part No. 785 112**  
**Type: TRS MS V1**

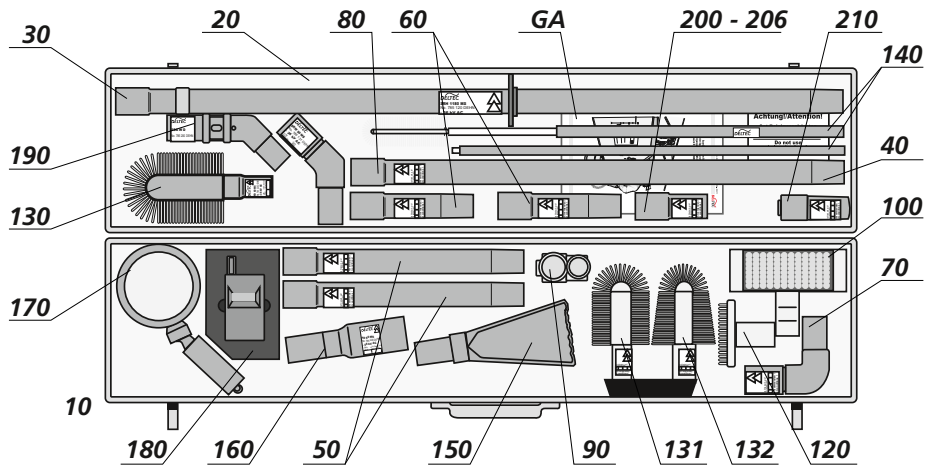

**Fig. 1b**

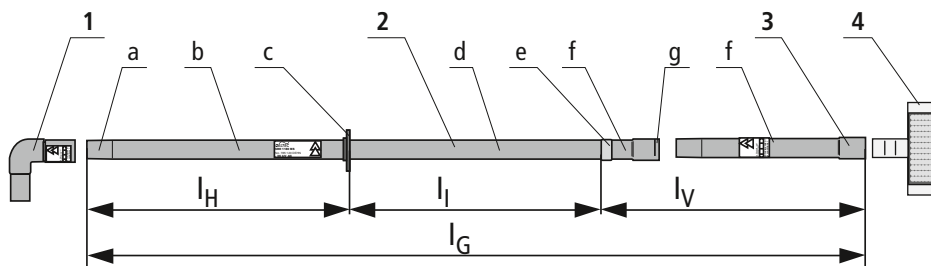

- 1 Angled intake tube
- 2 Intake tube with
  - a Lower connector
  - b Handle
  - c Hand guard with height  $h_a$
  - d Insulating element
  - e Red ring
  - f Extension
- 3 g Upper connector
- 4 Extension and/or angled intake tube  
 Cleaning head

$l_H$  Length of the handle = 540 mm  
 $l_I$  Length of the insulating element = 525 mm  
 $l_V$  Length of the extension  
 $l_{V \min} = 115 \text{ mm}$ ,  $l_{V \max} = 2515 \text{ mm}$   
 $l_G$  Total length of the draft tube  
 $l_{G \min} = 1180 \text{ mm}$ ,  $l_{G \max} = 3580 \text{ mm}$

**Note:**

The extensions of the TRS MS dry cleaning kit allow a maximum extension length of  $l_{V \max.} = 2515 \text{ mm}$  to reach distant parts of the installation in the vicinity of live parts.



## Notes



Surge Protection  
Lightning Protection  
Safety Equipment  
DEHN protects.

DEHN + SÖHNE  
GmbH + Co.KG.

Hans-Dehn-Str. 1  
Postfach 1640  
92306 Neumarkt  
Germany

Tel. +49 9181 906-0  
Fax +49 9181 906-1444  
export@dehn.de  
[www.dehn-international.com](http://www.dehn-international.com)